

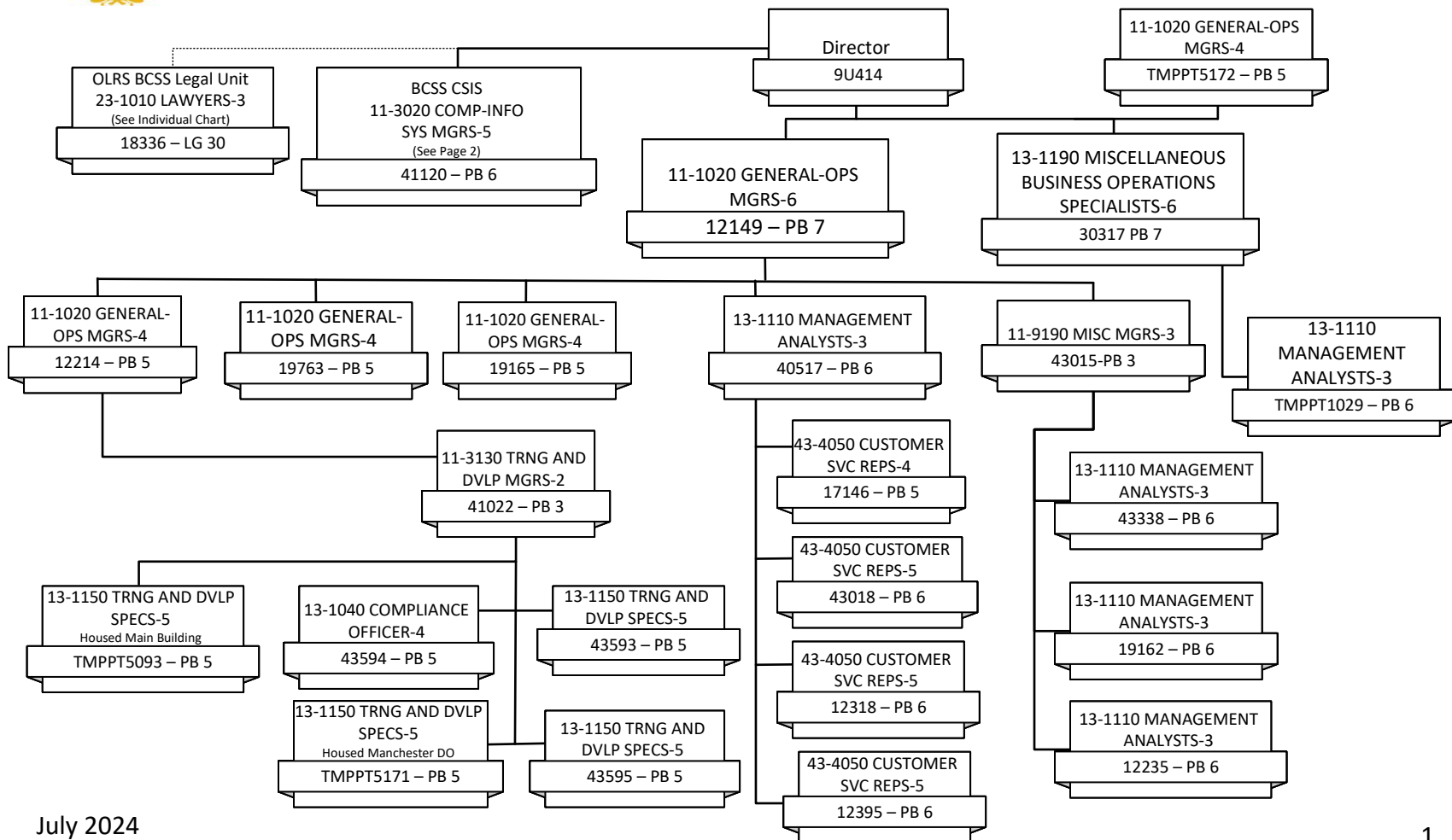

NH Department of Health and Human Services

Division of Economic Stability – Bureau of Child Support Services- Administration





NH Department of Health and Human Services

BCSS-Admin Child Support Information Systems

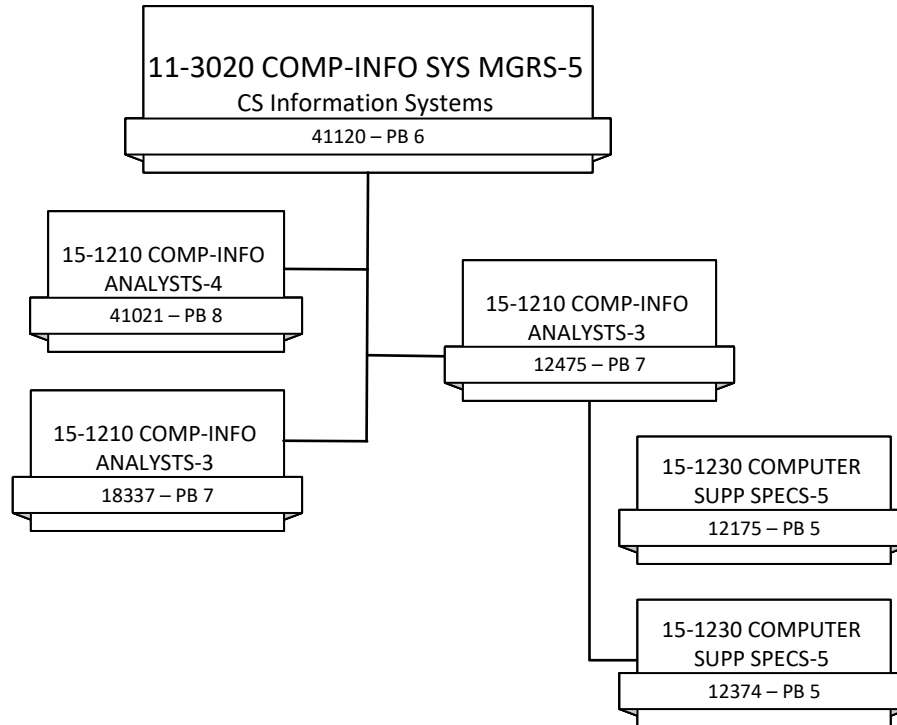



NH Department of Health and Human Services Child Support Services - Interstate

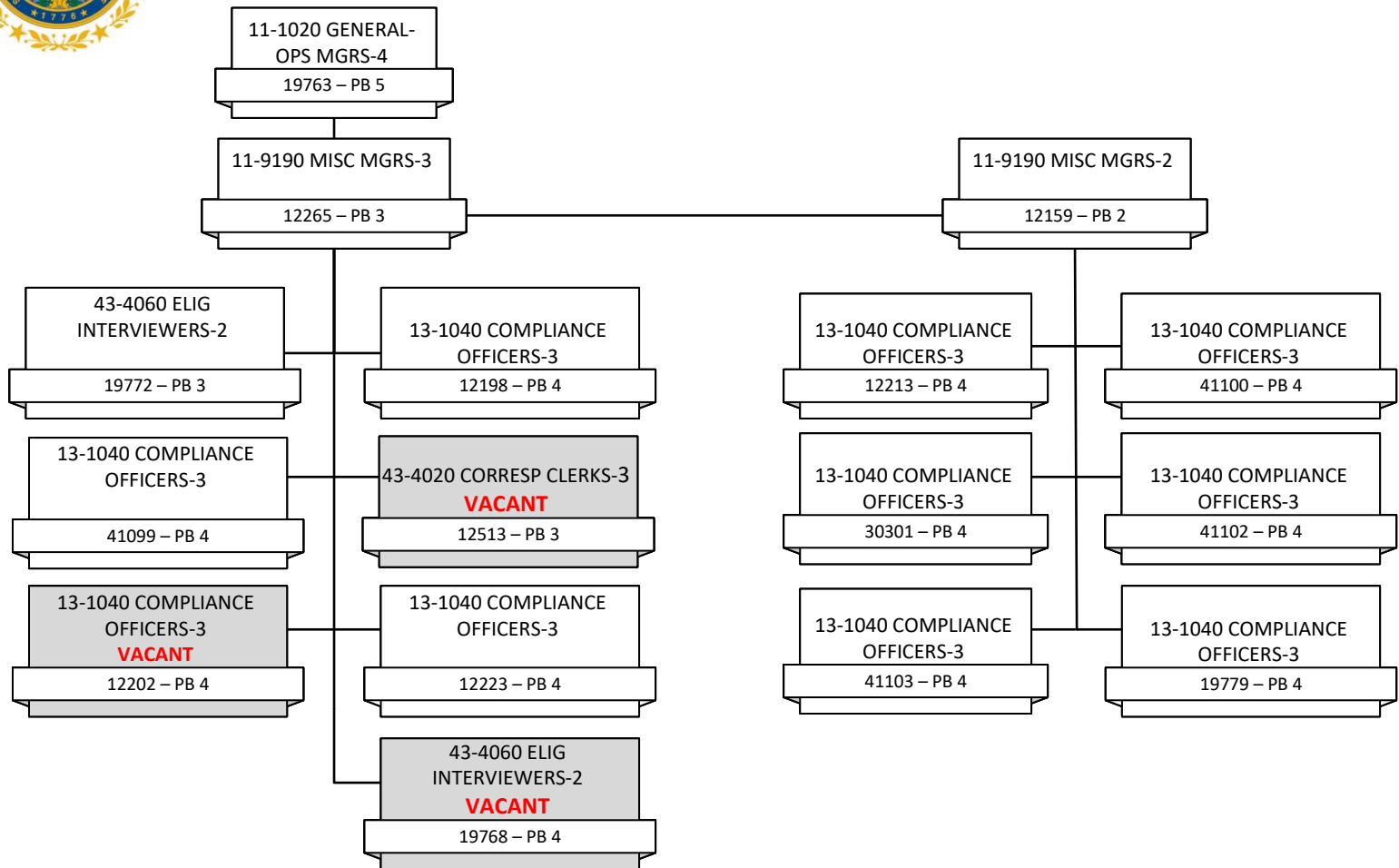



NH Department of Health and Human Services Child Support Services - Berlin District Office

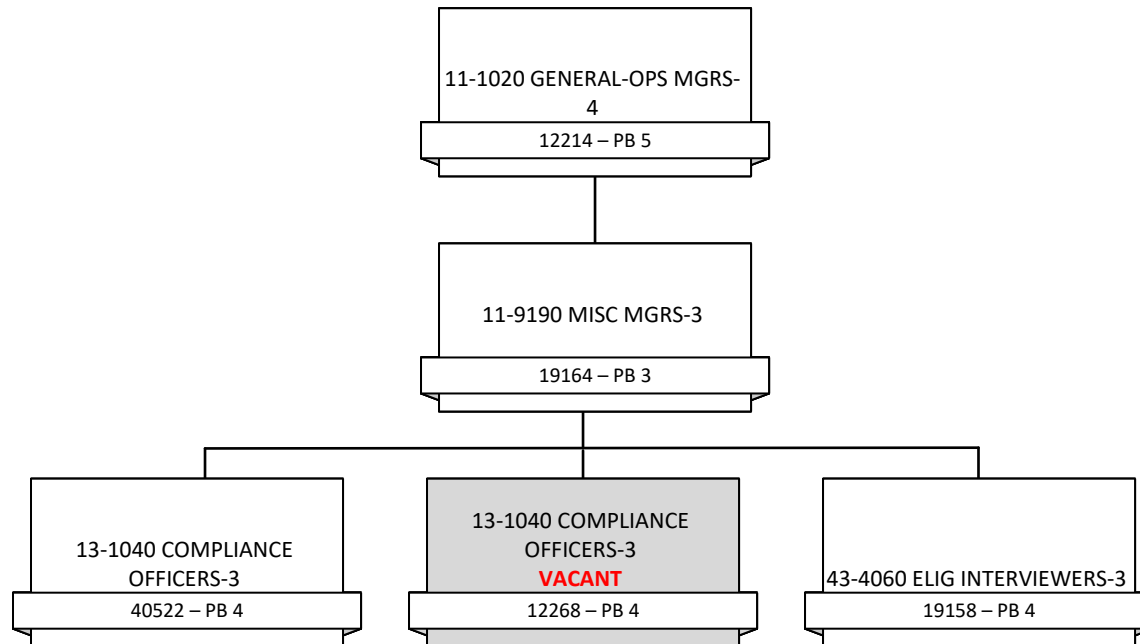



NH Department of Health and Human Services

Child Support Services - Claremont District Office

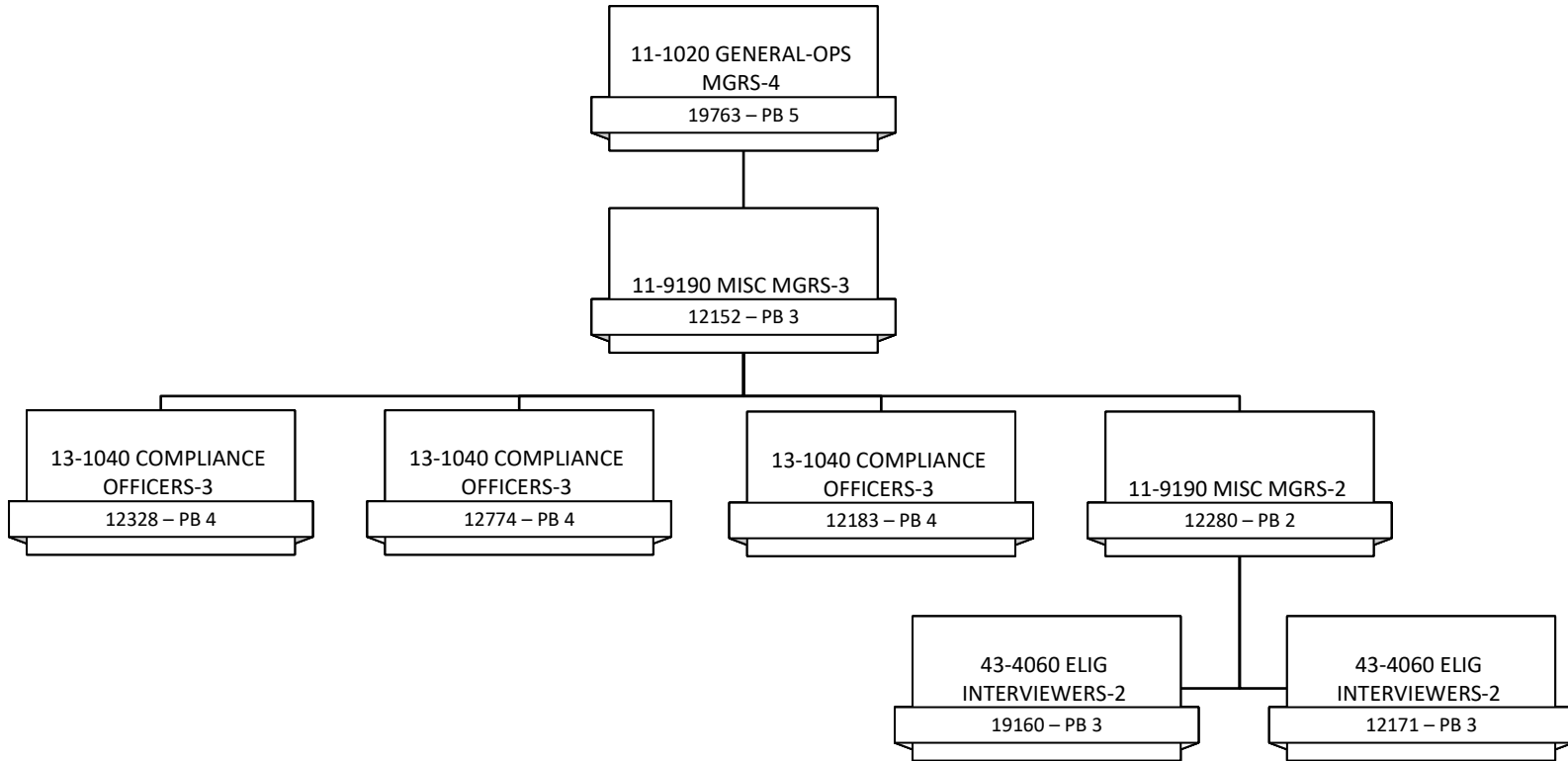



NH Department of Health and Human Services

Child Support Services - Concord District Office

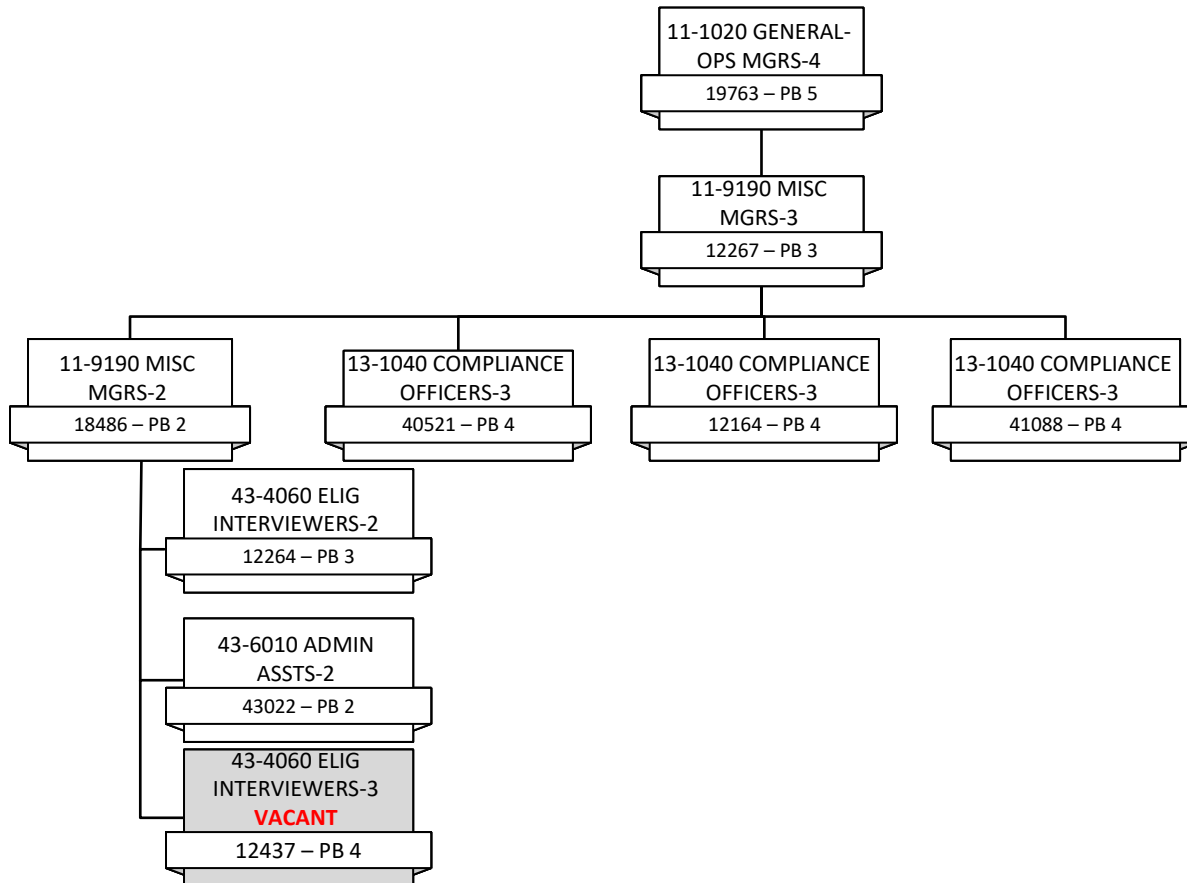



NH Department of Health and Human Services

Child Support Services - Conway District Office

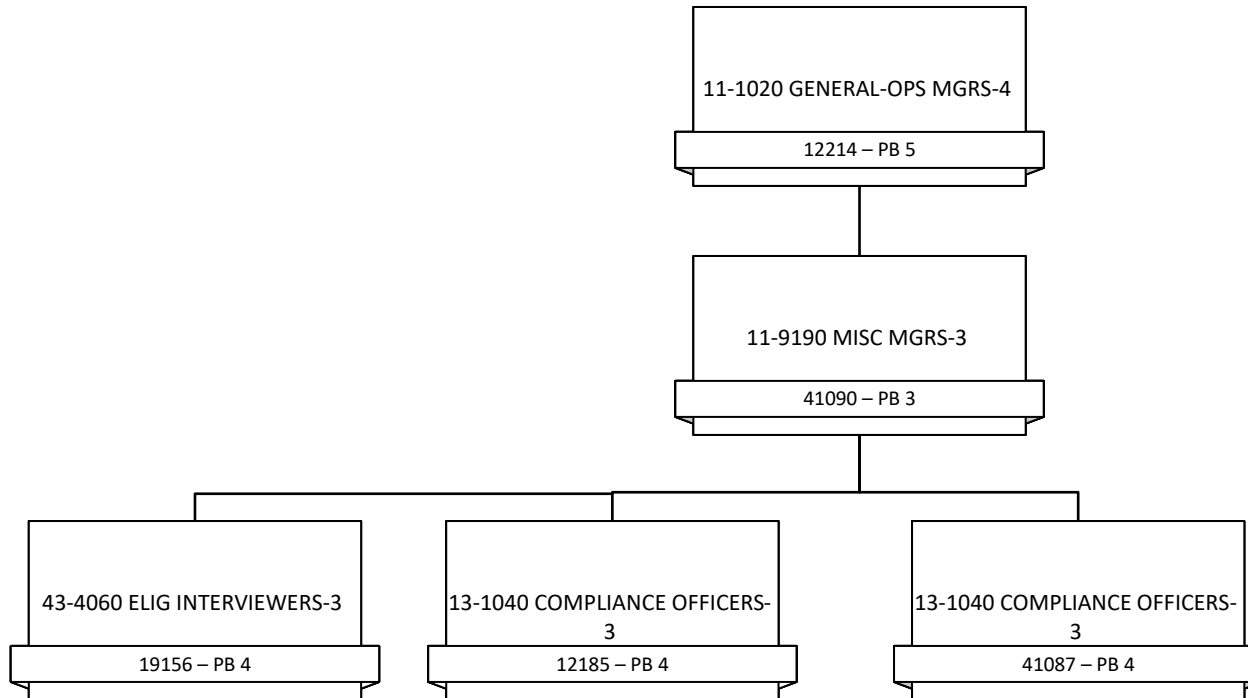



NH Department of Health and Human Services

Child Support Services - Keene District Office

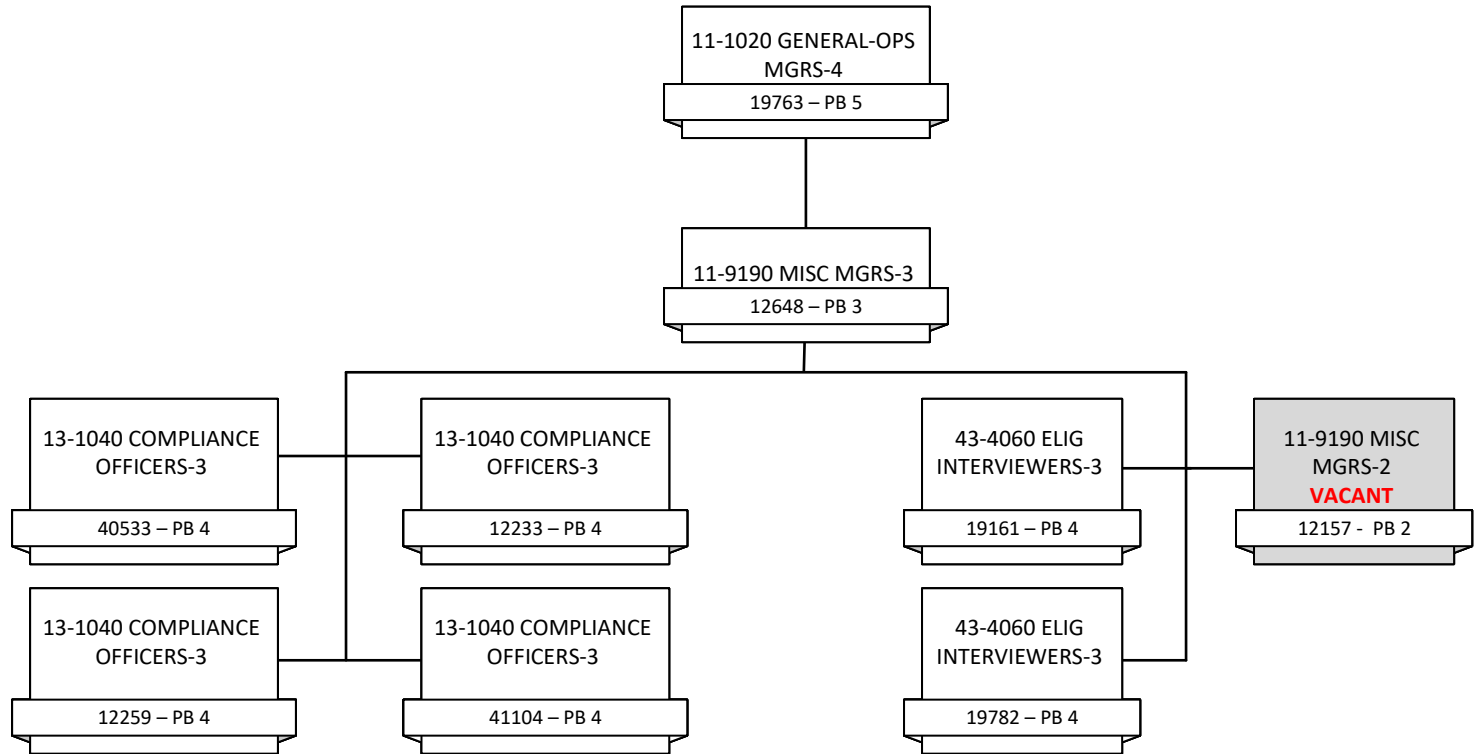



NH Department of Health and Human Services

Child Support Services - Laconia District Office

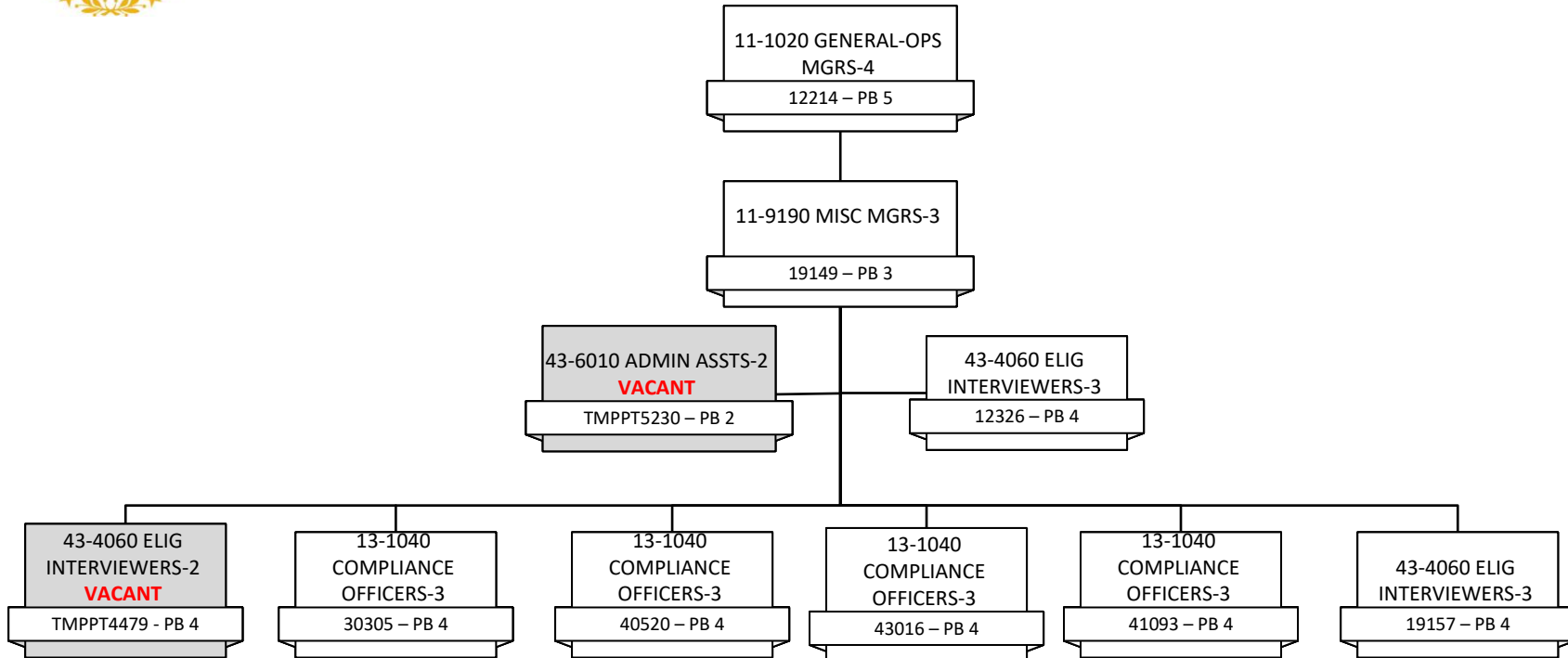



NH Department of Health and Human Services Child Support Services - Littleton District Office

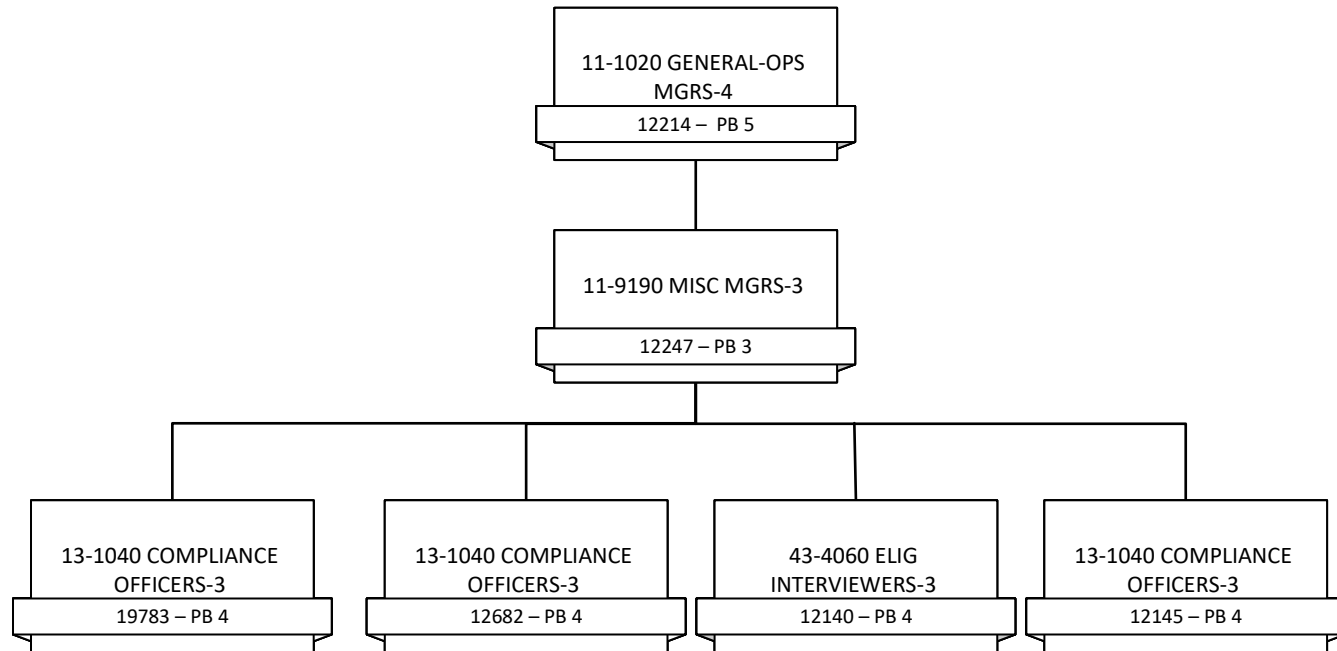



NH Department of Health and Human Services Child Support Services - Manchester District Office

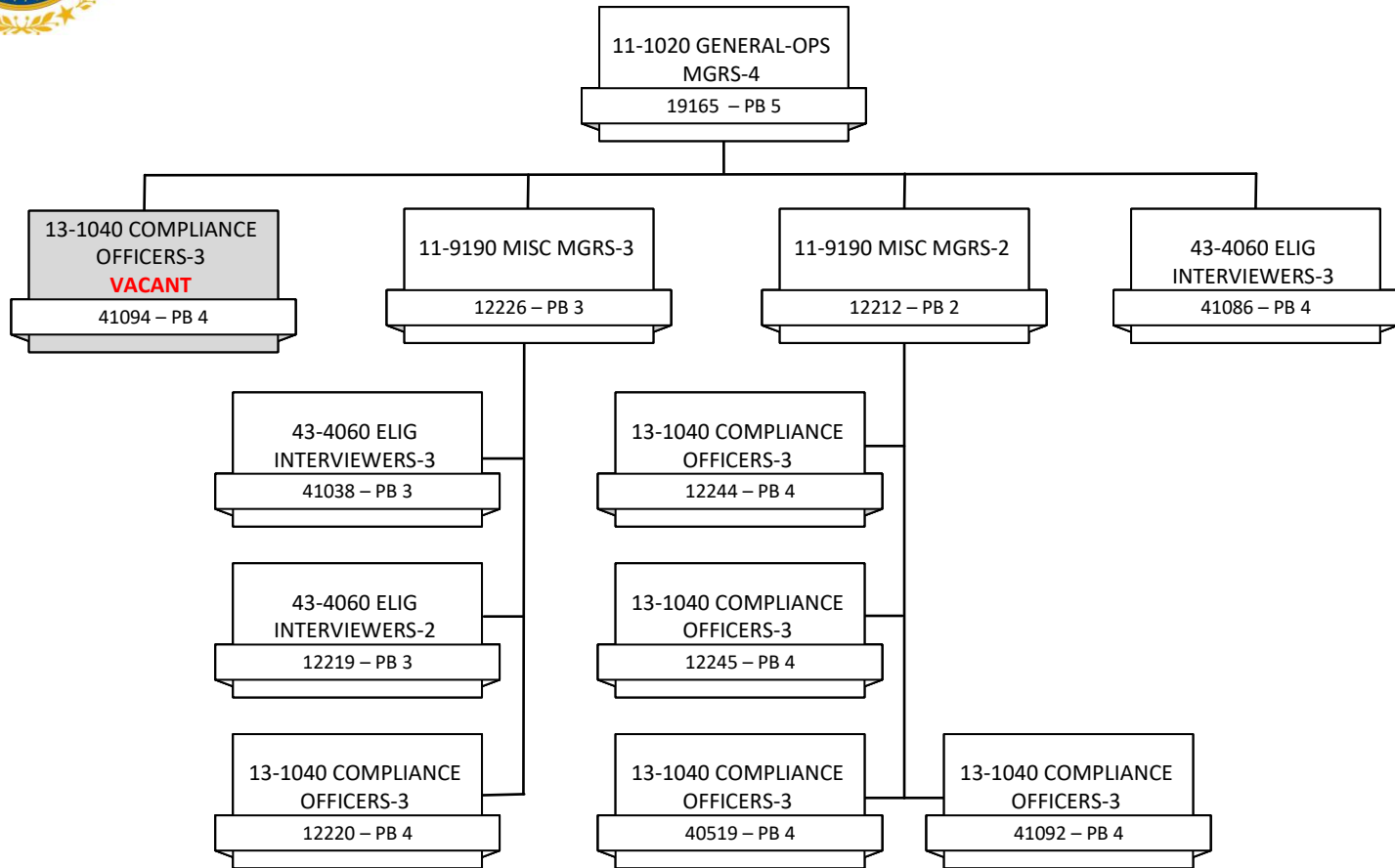



NH Department of Health and Human Services Child Support Services - Rochester District Office

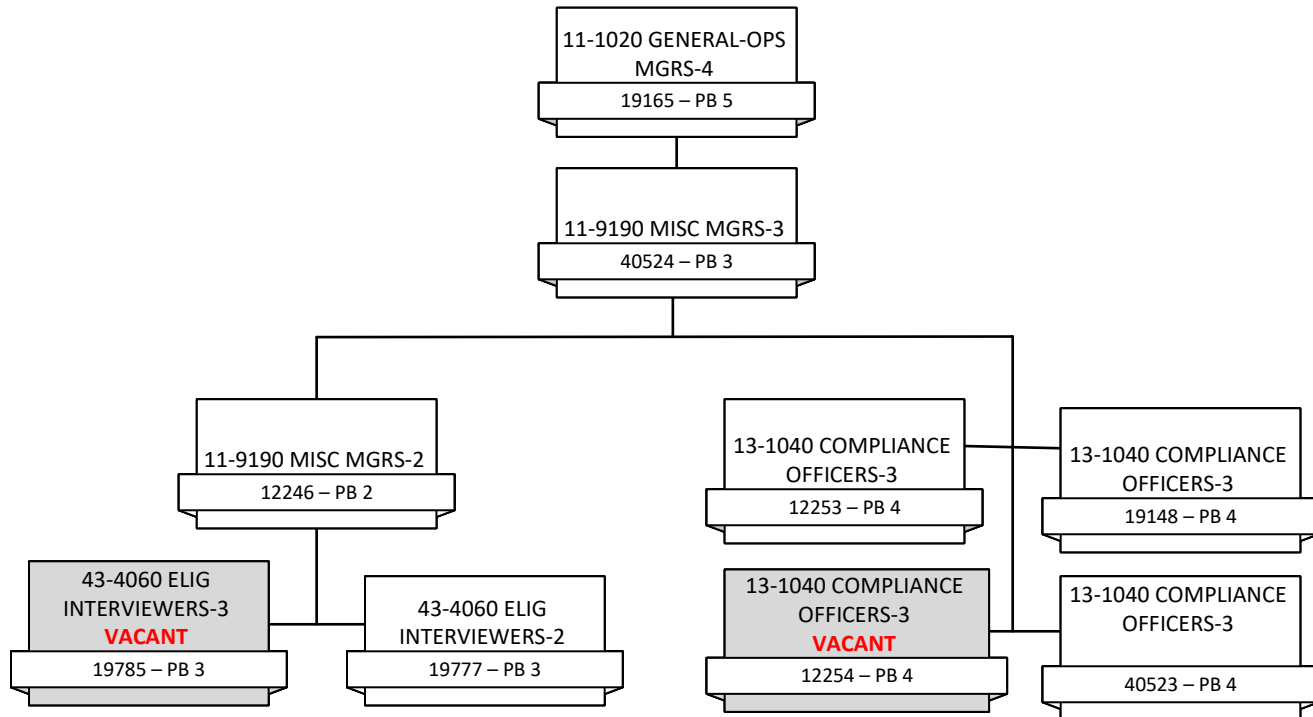



NH Department of Health and Human Services Child Support Services - Seacoast District Office

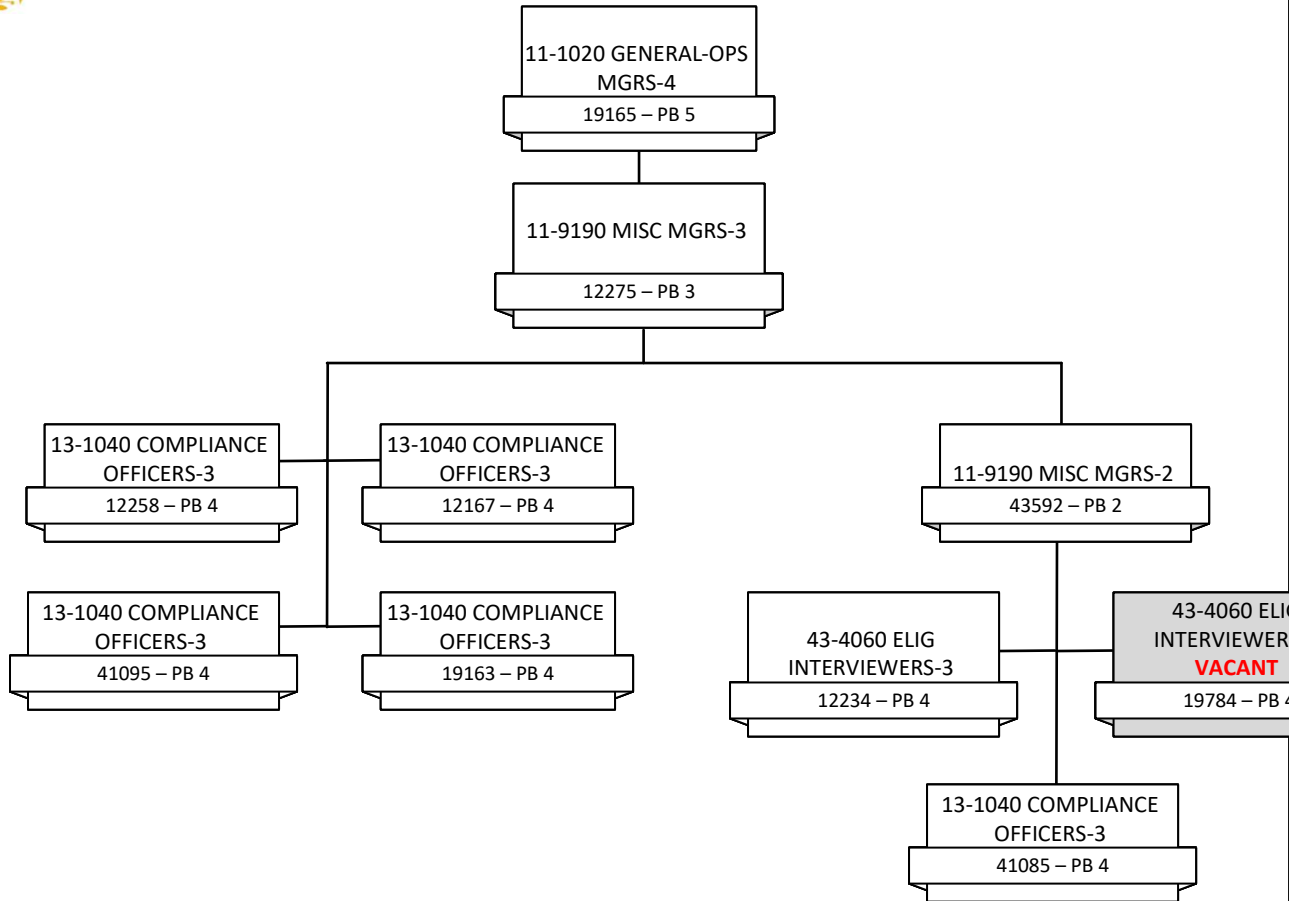



NH Department of Health and Human Services Child Support Services - Southern District Office

